

LAMINATOI MANUALI

MANUAL ROLLING MILLS - LAMINOIRS MANUELS - LAMINADORES MANUALES

Laminatoi a mano particolarmente indicati per artigiani e scuole orafe, adatti alla lavorazione d'oro, argento e metalli semi-preziosi. Sono realizzati con una solida struttura in ghisa fusa in grado di garantire robustezza e lunga durata. I cilindri, realizzati in materiale a tutta tempra, hanno una durezza di 63/65 Rockwell e lavorano su bronzine particolarmente resistenti all'usura.

Sono disponibili in due dimensioni, da 100 o 120 mm di larghezza cilindri, con o senza riduttore, per lastra, filo o lastra e filo combinati.

Manual rolling mills primarily used by craftsmen and jewelry schools, particularly suitable for the gold and silver workmanship as well also for all malleable metals. They are made with a strong cast iron frame for strength and durability.

The cylinders, constructed in totally tempered material have a 63/65 Rockwell hardness, and work on bronze bushings particularly resistant to wear.

They are available in two dimensions, 100 or 120 mm for the cylinders width, with or without reduction-gear, for flat, wire or combined flat and wire.

Laminoirs manuels particulièrement indiquée pour artisans et écoles, aptes au travail d'or, argent et métaux semi-précieux. Ils ont réalisés avec une structure solide en fonte apte à garantir robustesse et longue durée.

Les rouleaux, réalisés en matériau entièrement trempé, ont une dureté de 63/65 Rockwell, et travaillent sur des coussinets en bronze particulièrement résistants à l'usure.

Ils sont disponibles en deux dimensions, de 100 ou 120 mm de largeur de cylindres, avec ou sans réducteur, pour plaque, fil ou plaque et fil combinés.

Laminadores manuales particularmente indicados para artesanos y escuelas, aptos a la elaboración de oro, plata y metales semilla-preciosos. Ellos son realizados con una sólida estructura de hierro fundido capaz de garantizar robustez y larga duración. Los cilindros, fabricados de material completamente templado, tienen una dureza de 63/65 Rockwell y trabajan sobre bujes de alta resistencia al desgaste.

Están disponibles en dos dimensiones, es decir, con cilindros de 100 ó 120 mm de ancho, con o sin reductor, para chapa-hilo o chapa e hilo combinados.

AZLAMINATOI CON RIDUTTORE – ROLLING MILLS WITH REDUCTION UNIT – LAMINOIRS AVEC REDUCTEUR – LAMINADORES CON REDUCTOR

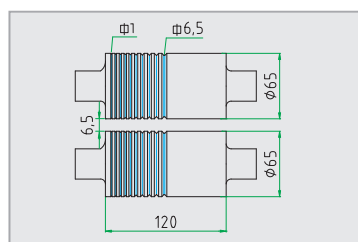

LF120
mm 345x215x415h - kg 38

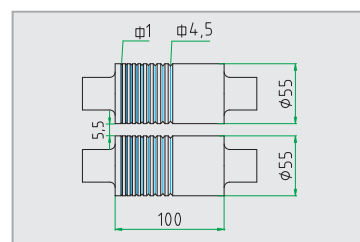

LF100
mm 315x215x400h - kg 33

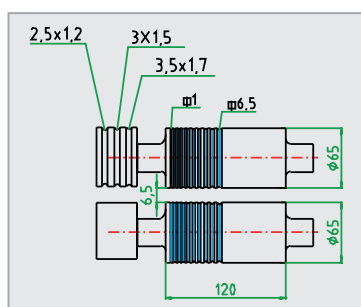

LF120RR
mm 375x215x415h - kg 40

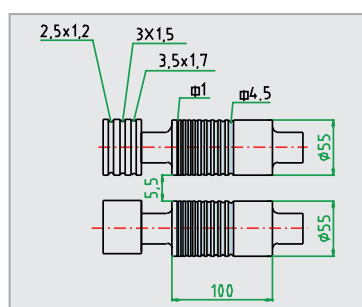

LF100RR
mm 345x215x400h - kg 35





L120

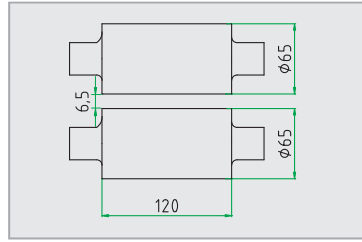

L120
mm 345x215x415h - kg 38

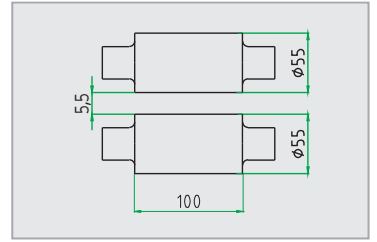

L100
mm 315x215x400h - kg 33

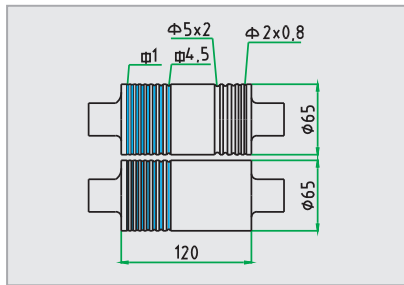

LF120MT
mm 345x215x415h - kg 38



L120MT



F120

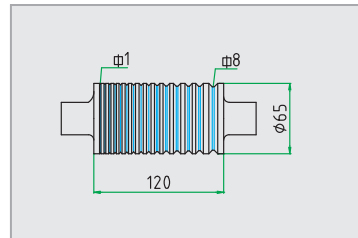

F120
mm 345x215x415h - kg 38



CLM
mm 240x240x830h - kg 11

Colonnina per laminatoio a mano
Pedestal for manual rolling mill
Colonnette pour laminoir manuel
Columnas para laminador manual

LAMINATOI SENZA RIDUTTORE – ROLLING MILLS WITHOUT REDUCTION UNIT – LAMINOIRS SANS REDUCTEUR – LAMINADORES SIN REDUCTOR

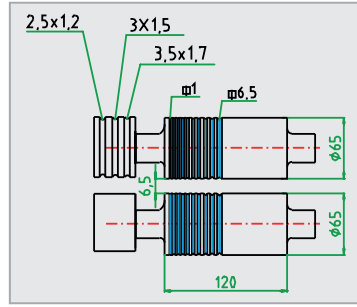

LF120R
mm 320x215x415h - kg 33

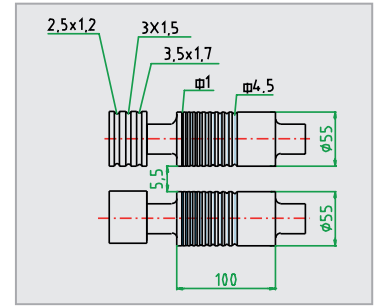

LF100R
mm 300x215x400h - kg 28

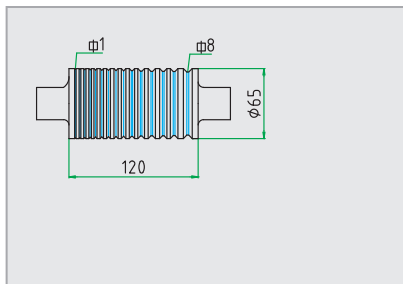

F120R
mm 320x215x415h - kg 33

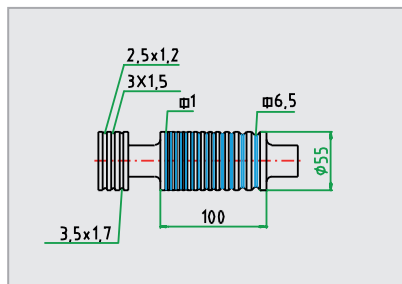

F100R
mm 300x215x400h - kg 28

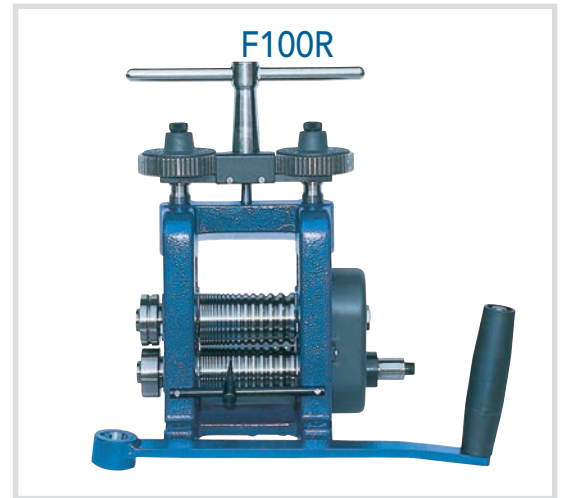

LAMINATOI COMBINATI – DOUBLE ROLLING MILLS – LAMINOIRS DOUBLE – LAMINADORES DOBLE

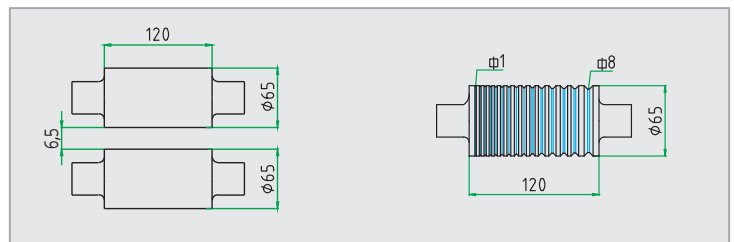

LF120DP
mm 650x240x1245h - kg 91

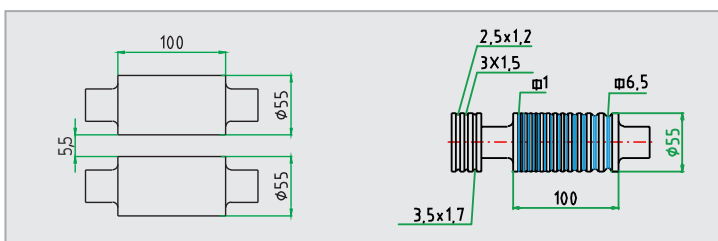

LF100DP
mm 650x240x1230h - kg 76

LAMINATOI SERIE ECOMILL

ROLLING MILLS SERIES ECOMILL – LAMINOIRS SERIE ECOMILL - LAMINADORES SERIE ECOMILL

Nuova gamma di laminatoi manuali con struttura in acciaio. I cilindri ruotano su supporti sinterizzati a lunga durata impregnati di olio lubrificante particolarmente resistenti all'usura e privi di manutenzione.

Hanno le stesse capacità di lavoro dei corrispondenti modelli tradizionali con struttura in ghisa e sono disponibili con cilindri larghi 100 o 120 mm, per lastra, filo o lastra/filo combinati, con o senza riduttore (riduzione 4 a 1). Possono essere equipaggiati di rulli laterali incisi ed essere montati su colonnine.

New series of manual rolling mills realized with steel structure. The rollers rotate on long lasting sintered bearings impregnated with lubricant oil, particularly resistant to wear and free from maintenance.

They have same working capacity as the traditional models with cast iron structure and they are available with rollers of 100 or 120 mm width, for flat, wire or flat and wire combined, with or without reduction gears (4 to 1 reduction). They can be equipped by engraved side rollers and it's possible to place them on pedestals.

Novelle gamme des laminoirs manuels avec structure en acier. Les rouleaux tournent sur des supports frittés à long durée de vie, imprégnés d'huile lubrifiante, particulièrement résistants à l'usure et que ne nécessitant pas d'entretien.

Ils ont les mêmes capacités de travail que les modèles traditionnel avec structure en fonte et ils sont disponibles avec cylindres de 100 ou 120 mm de largeur, pour plaque, fil ou plaque et fil combinés, avec ou sans reducteur (reduction 4 à 1). Ces laminoirs peuvent être équipés avec des rouleaux latéraux gravés et ils peuvent être montés sur des colonnettes.

Nueva gama des laminadores a mano con estructura de acero. Los cilindros giran sobre soportes sinterizados de larga duración impregandolos de aceite lubricante con alta resistencia al desgaste sin mantenimiento.

La capacidades de trabajo es las mismas que el modelo tradicional de hierro fundido. Están disponibles con cilindros de 100 ó 120 mm de ancho, para chapa, hilo o chapa e hilo combinados, con o sin reductor (reducciones 4:1). Es posible montar los rodillos laterales grabados y se pueden montar sobre columnas

LAMINATOI CON RIDUTTORE – ROLLING MILLS WITH REDUCTION UNIT – LAMINOIRS AVEC REDUCTEUR – LAMINADORES CON REDUCTOR



ELF120

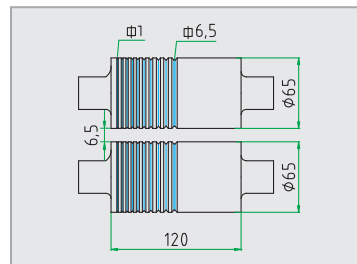

ELF120

mm 350x110x330h - kg 33,5

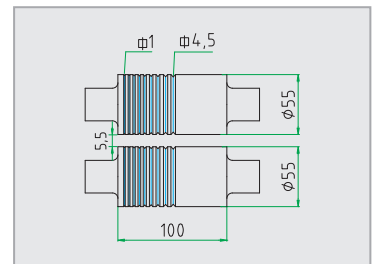

ELF100

mm 330x110x330h - kg 28

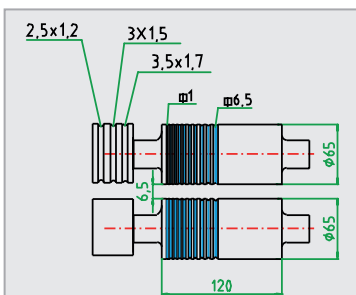

ELF120RR

mm 380x110x340h - kg 35

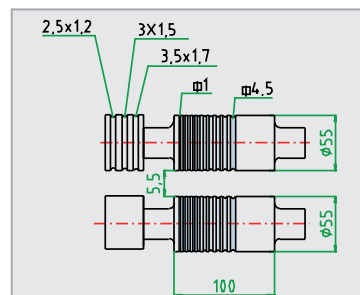

ELF100RR

mm 360x110x330h - kg 30



ELF100RR



EL100

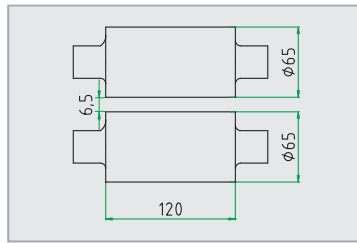

EL120

mm 350x110x340h - kg 33,5

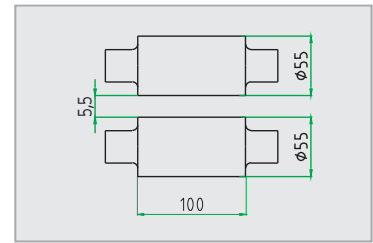

EL100

mm 330x110x330h - kg 28

LAMINATOI SENZA RIDUTTORE – ROLLING MILLS WITHOUT REDUCTION UNIT – LAMINOIRS SANS REDUCTEUR – LAMINADORES SIN REDUCTOR

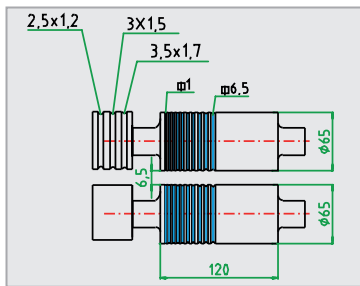

ELF120R

mm 320x110x340h - kg 27

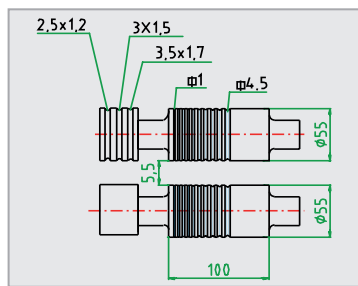

ELF100R

mm 300x110x330h - kg 24



ELF100R



EF100R

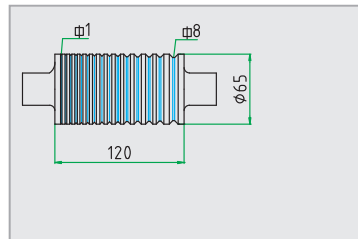

ELF120R

mm 320x110x340h - kg 27

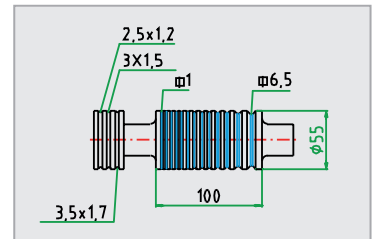

EF100R

mm 300x110x330h - kg 24



Colonnina per laminatoio a mano
Pedestal for manual rolling mill
Colonnette pour laminoir manuel
Columnas para laminador manual

CLM

mm 240x240x830h - kg 11